



## CARTOUCHES



### SERMA OUTILLAGE

91 route de Bonsecours 59163 Condé sur l'Escaut FRANCE  
Tel: 03-27-30-12-31 Fax: 03-27-30-17-13



## Fixation

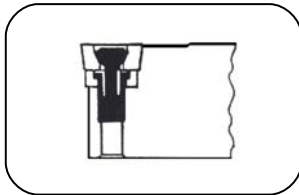

**Fixation par vis Torx**

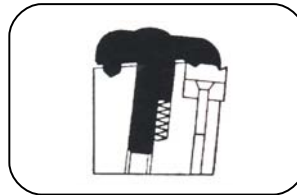

**Fixation par bride**

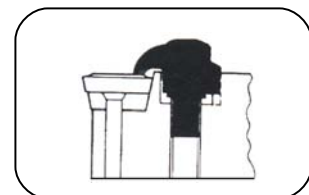

**Fixation par bride**

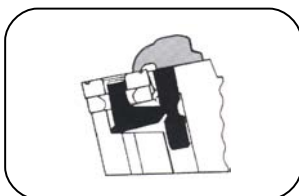

**Fixation par  
levier + bride**

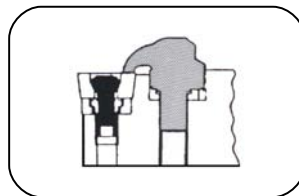

**Fixation par  
Vis + bride**



**Fixation par  
bride N**

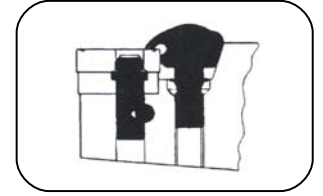

**Fixation par  
bride - coin**

### **SERMA OUTILLAGE**

91 route de Bonsecours 59163 Condé sur l'Escaut FRANCE  
Tel: 03-27-30-12-31 Fax: 03-27-30-17-13



## Code ISO

### Cartouches - Code ISO

<b>P</b>	<b>C</b>	<b>L</b>	<b>N</b>	<b>R</b>	<b>16</b>	<b>C</b>	<b>A</b>	<b>-</b>	<b>12</b>
1	2	3	4	5	6	7	8	9	10

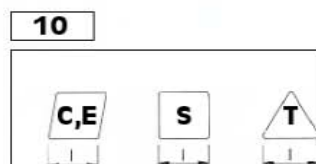
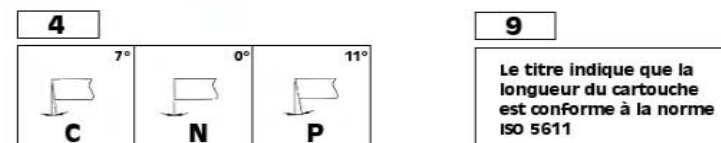
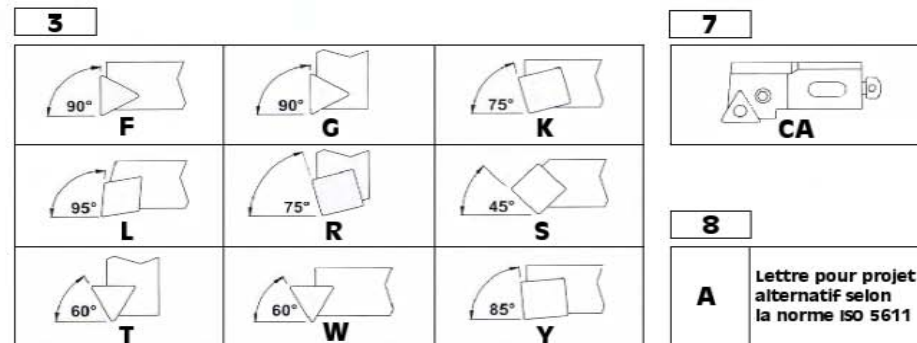
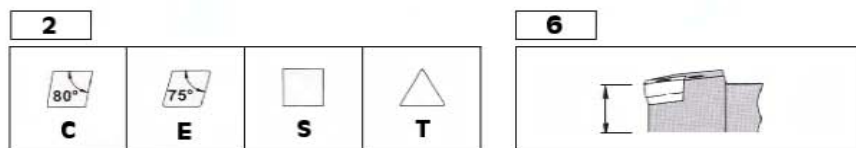
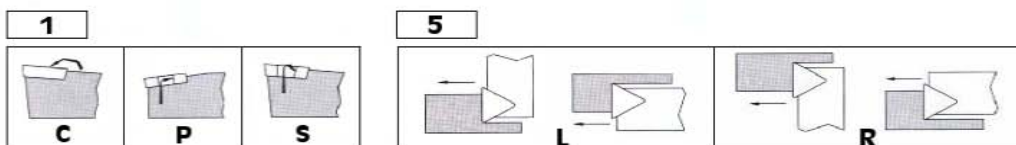

### SERMA OUTILLAGE

91 route de Bonsecours 59163 Condé sur l'Escaut FRANCE  
 Tel: 03-27-30-12-31 Fax: 03-27-30-17-13



## CSKP 75°

Cartouches avec blocage par bride

	CODE ISO	D	h	h1	L	L1	f	b
D	CSKP R/L 10CA-09	40	15	10	50	30	14	11
D	CSKP R/L 12CA-12	50	20	12	55	35	20	16
D	CSKP R/L 16CA-12	55	25	16	63	38	25	20



Pièces de rechange										
CSKP R/L 10CA-09	BC04	2,5	-	-	CC05	G4	2	JC06	AC16	4
CSKP R/L 12CA-12	BC05	3	-	-	CC05	G5	2,5	JC06	AC06	4
CSKP R/L 16CA-12	BC05	3	AA12	LL00	CC06	G5	2,5	JC08	AC08	5

Plaquettes	d	l	s	SPMR	SPUN
SP..0903..	9,52	9,52	3,18		
SP..1203..	12,7	12,7	3,18		

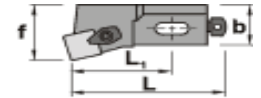

## CSKP 75°

Cartouches avec blocage par bride

	CODE ISO	D	h	h1	L	f	b
M	CSKP R/L 10CA-09	40	15	10	50	14	11
M	CSKP R/L 12CA-12	50	20	12	55	20	15
M	CSKP R/L 16CA-12	55	25	16	63	25	20



Pièces de rechange										
CSKP R/L 10CA-09	04	2,5	-	-	VA5	GR10	2	VB10	4	
CSKP R/L 12CA-12	07	3	-	-	VA5	GR12	2	VB12	4	
CSKP R/L 16CA-12	07	3	A11	L1	VA6	GR16	2	VB16	5	

Plaquettes	d	l	s	SPMR	SPUN
SP..0903..	9,52	9,52	3,18		
SP..1203..	12,7	12,7	3,18		



## CSSP 45°

Cartouches avec blocage par bride

	CODE ISO	D	h	h1	L	L1	f	b
D	CSSP R/L 10CA-09	40	15	10	44	24	14	11
D	CSSP R/L 12CA-12	50	20	12	47	27	20	16
D	CSSP R/L 16CA-12	55	25	16	53	28	25	20



Pièces de rechange										
CSSP R/L 10CA-09	BC04	2,5	-	-	CC05	G4	2	JC06	AC16	4
CSSP R/L 12CA-12	BC05	3	-	-	CC05	G5	2,5	JC06	AC06	4
CSSP R/L 16CA-12	BC05	3	AA12	LL00	CC06	G5	2,5	JC08	AC08	5

Plaquettes	d	l	s	SPMR	SPUN
SP..0903..	9,52	9,52	3,18		
SP..1203..	12,7	12,7	3,18		

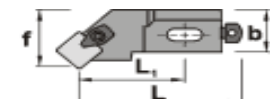

## SERMA OUTILLAGE

91 route de Bonsecours 59163 Condé sur l'Escaut FRANCE  
Tel: 03-27-30-12-31 Fax: 03-27-30-17-13



## CSSP 45°

Cartouches avec blocage par bride

	CODE ISO	D	h	h1	L	f	b
M	CSSP R/L 12CA-12	50	20	12	47	20	15
M	CSSP R/L 16CA-12	55	21	16	53	25	20



Pièces de rechange									
CSSP R/L 12CA-12	07	3	-	-	VA5	GR12	2	VB12	4
CSSP R/L 16CA-12	07	3	A11	L1	VA6	GR16	2	VB16	5

Plaquettes	d	l	s	SPMR	SPUN
SP..1203..	12,7	12,7	3,18		

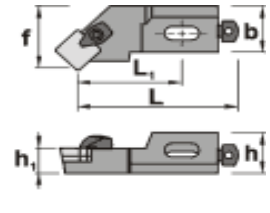

## CTFP 90°

Cartouches avec blocage par bride

	CODE ISO	D	h	h1	L	L1	f	b
D	CTFP R/L 10CA-11	40	15	10	50	30	14	11
D	CTFP R/L 12CA-16	50	20	12	55	35	20	16
D	CTFP R/L 16CA-16	55	25	16	63	38	25	20



Pièces de rechange										
CTFP R/L 10CA-11	BC04	2,5	-	-	CC05	G4	2	JC06	AC16	4
CTFP R/L 12CA-16	BC05	3	-	-	CC05	G5	2,5	JC06	AC06	4
CTFP R/L 16CA-16	BC05	3	A8	LL00	CC06	G5	2,5	JC08	AC08	5

Plaquettes	d	l	s	TPMN	TPMR	TPUN	TPUX R/L
TP..1103..	6,35	11	3,18				
TP..1603..	9,52	16,5	3,18				

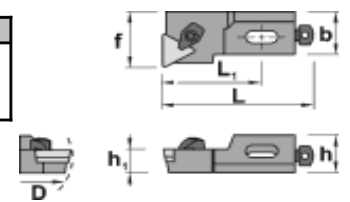

## CTFP 90°

Cartouches avec blocage par bride

	CODE ISO	D	h	h1	L	f	b
M	CTFP R/L 10CA-11	40	15	10	50	14	11
M	CTFP R/L 12CA-16	50	20	12	55	20	15
M	CTFP R/L 16CA-16	55	21	16	63	25	20



Pièces de rechange									
CTFP R/L 10CA-11	04	2,5	-	-	VA5	GR10	2	VB10	4
CTFP R/L 12CA-16	07	3	-	-	VA5	GR12	2	VB12	4
CTFP R/L 16CA-16	07	3	A8	L1	VA6	GR16	2	VB16	5

Plaquettes	d	l	s	TPMR	TPUN
TP..1103..	6,35	11	3,18		
TP..1603..	9,52	16,5	3,18		

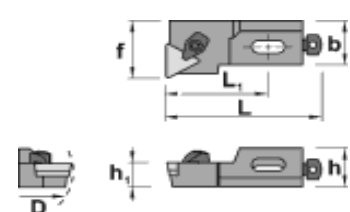



## CTGP 90°

Cartouches avec blocage par bride

	CODE ISO	D	h	h1	L	L1	f	b
D	CTGP R/L 10CA-11	40	15	10	50	30	14	11
D	CTGP R/L 12CA-16	50	20	12	55	35	20	16
D	CTGP R/L 16CA-16	60	25	16	63	38	25	20



Pièces de rechange										
CTGP R/L 10CA-11	BC04	2,5	-	-	CC05	G4	2	JC06	AC16	4
CTGP R/L 12CA-16	BC05	3	-	-	CC05	G5	2,5	JC06	AC06	4
CTGP R/L 16CA-16	BC05	3	A8	LL00	CC06	G5	2,5	JC08	AC08	5

Plaquettes	d	l	s	TPMN	TPMR	TPUN	TPUX
TP..1103..	6,35	11	3,18				
TP..1603..	9,52	16,5	3,18				

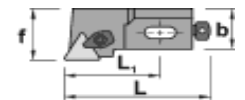

## CTGP 90°

Cartouches avec blocage par bride

	CODE ISO	D	h	h1	L	f	b
M	CTGP R/L 10CA-11	40	15	10	50	14	11
M	CTGP R/L 12CA-16	50	20	12	55	20	15
M	CTGP R/L 16CA-16	55	21	16	63	25	20



Pièces de rechange										
CTGP R/L 10CA-11	04	2,5	-	-	VA5	GR10	2	VB10	4	
CTGP R/L 12CA-16	07	3	-	-	VA5	GR12	2	VB12	4	
CTGP R/L 16CA-16	07	3	A8	L1	VA6	GR16	2	VB16	5	

Plaquettes	d	l	s	TPMR	TPUN
TP..1103..	6,35	11	3,18		
TP..1603..	9,52	16,5	3,18		



## CTSP 45°

Cartouches avec blocage par bride

	CODE ISO	D	h	h1	L	L1	f	b
D	CTSP R/L 10CA-11	40	15	10	44	24	14	11
D	CTSP R/L 12CA-16	50	20	12	47	27	20	16
D	CTSP R/L 16CA-16	55	25	16	53	28	25	20



Pièces de rechange										
CTSP R/L 10CA-11	BC04	2,5	-	-	CC05	G4	2	JC06	AC16	4
CTSP R/L 12CA-16	BC05	3	-	-	CC05	G5	2,5	JC06	AC06	4
CTSP R/L 16CA-16	BC05	3	A8	LL00	CC06	G5	2,5	JC08	AC08	5

Plaquettes	d	l	s	TPMN	TPMR	TPUN	TPUX
TP..1103..	6,35	11	3,18				
TP..1603..	9,52	16,5	3,18				

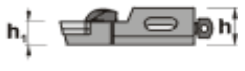
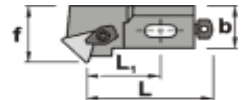

## SERMA OUTILLAGE

91 route de Bonsecours 59163 Condé sur l'Escaut FRANCE  
Tel: 03-27-30-12-31 Fax: 03-27-30-17-13





## CTSP 45°

Cartouches avec blocage par bride

	CODE ISO	D	h	h1	L	f	b
M	CTSP R/L 10CA-11	40	15	10	44	14	11
M	CTSP R/L 12CA-16	50	20	12	47	20	15
M	CTSP R/L 16CA-16	55	21	16	53	25	20



Pièces de rechange									
CTSP R/L 10CA-11	04	2,5	-	-	VA5	GR10	2	VB10	4
CTSP R/L 12CA-16	07	3	-	-	VA5	GR12	2	VB12	4
CTSP R/L 16CA-16	07	3	A8	L1	VA6	GR16	2	VB16	5

Plaquettes	d	l	s	TPMR	TPUN
TP..1103..	6,35	11	3,18		
TP..1603..	9,52	16,5	3,18		



## CTTP 60°

Cartouches avec blocage par bride

	CODE ISO	D	h	h1	L	L1	f	b
D	CTTP R/L 10CA-11	40	15	10	50	30	9	11
D	CTTP R/L 12CA-16	50	20	12	55	35	13	16
D	CTTP R/L 16CA-16	55	25	16	63	38	15	20



Pièces de rechange										
CTTP R/L 10CA-11	BC04	2,5	-	-	CC05	G4	2	JC06	AC16	4
CTTP R/L 12CA-16	BC05	3	-	-	CC05	G5	2,5	JC06	AC06	4
CTTP R/L 16CA-16	BC05	3	A8	LL00	CC06	G5	2,5	JC08	AC08	5

Plaquettes	d	l	s	TPMN	TPMR	TPUN	TPUX
TP..1103..	6,35	11	3,18				
TP..1603..	9,52	16,5	3,18				

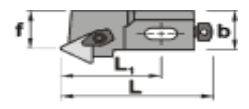

## CTTP 60°

Cartouches avec blocage par bride

	CODE ISO	D	h	h1	L	f	b
M	CTTP R/L 10CA-11	40	15	10	50	9	11
M	CTTP R/L 12CA-16	50	20	12	55	13	15
M	CTTP R/L 16CA-16	55	21	16	63	15	20



Pièces de rechange									
CTTP R/L 10CA-11	04	2,5	-	-	VA5	GR10	2	VB10	4
CTTP R/L 12CA-16	07	3	-	-	VA5	GR12	2	VB12	4
CTTP R/L 16CA-16	07	3	A8	L1	VA6	GR16	2	VB16	5

Plaquettes	d	l	s	TPMR	TPUN
TP..1103..	6,35	11	3,18		
TP..1603..	9,52	16,5	3,18		

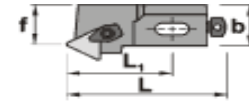

## SERMA OUTILLAGE

91 route de Bonsecours 59163 Condé sur l'Escaut FRANCE  
Tel: 03-27-30-12-31 Fax: 03-27-30-17-13



## CTWP 60°

Cartouches avec blocage par bride

	CODE ISO	D	h	h1	L	L1	f	b
D	CTWP R/L 10CA-11	40	15	10	44	24	14	11
D	CTWP R/L 12CA-16	50	20	12	47	27	20	16
D	CTWP R/L 16CA-16	55	25	16	53	28	25	20



Pièces de rechange										
CTWP R/L 10CA-11	BC04	2,5	-	-	CC05	G4	2	JC06	AC16	4
CTWP R/L 12CA-16	BC05	3	-	-	CC05	G5	2,5	JC06	AC06	4
CTWP R/L 16CA-16	BC05	3	A8	LL00	CC06	G5	2,5	JC08	AC08	5

Plaquettes	d	l	s	TPMN	TPMR	TPUN	TPUX R/L
TP..1103..	6,35	11	3,18				
TP..1603..	9,52	16,5	3,18				

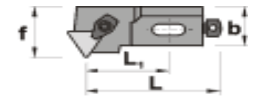

## CTWP 60°

Cartouches avec blocage par bride

	CODE ISO	D	h	h1	L	f	b
M	CTWP R/L 10CA-11	40	15	10	44	14	11
M	CTWP R/L 12CA-16	50	20	12	47	20	15
M	CTWP R/L 16CA-16	55	21	16	53	25	20



Pièces de rechange										
CTWP R/L 10CA-11	04	2,5	-	-	VA5	GR10	2	VB10	4	
CTWP R/L 12CA-16	07	3	-	-	VA5	GR12	2	VB12	4	
CTWP R/L 16CA-16	07	3	A8	L1	VA6	GR16	2	VB16	5	

Plaquettes	d	l	s	TPMR	TPUN
TP..1103..	6,35	11	3,18		
TP..1603..	9,52	16,5	3,18		



## PCFN 90°

Cartouches avec blocage par levier

	CODE ISO	D	h	h1	L	L1	f	b
D	PCFN R/L 16CA-12	60	25	16	63	38	25	20
D	PCFN R/L 20CA-12	70	30	20	70	40	25	20
D	PCFN R/L 25CA-16	100	35	25	100	50	32	25



Pièces de rechange										
PCFN R/L 16CA-12	B12	VC48	3	A1	D1	CC06	G5	PO12	2,5	
PCFN R/L 20CA-12	B1	C1	3	A1	D1	CC06	G6	PO12	3	
PCFN R/L 25CA-16	B5	C5	3	Y2	D5	CC08	G8	PO15	4	

Pièces de rechange			
PCFN R/L 16CA-12	JC08	AC08	5
PCFN R/L 20CA-12	JC08	AC08	5
PCFN R/L 25CA-16	JC10	AC10	6

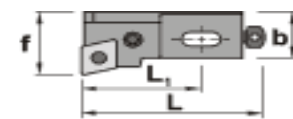

Plaquettes	d	l	s	CNMG
CNM...1204..	12,7	12,9	4,76	
CNM...1606..	15,88	16,1	6,35	



## SERMA OUTILLAGE

91 route de Bonsecours 59163 Condé sur l'Escaut FRANCE

Tel: 03-27-30-12-31 Fax: 03-27-30-17-13





## PCFN 90°

Cartouches avec blocage par levier

	CODE ISO	D	h	h1	L	f	b
M	PCFN R/L 12CA-12	50	20	12	55	20	15
M	PCFN R/L 16CA-12	55	25	16	63	25	20
M	PCFN R/L 20CA-16	70	30	20	70	20	20
M	PCFN R/L 25CA-19	100	38	25	100	32	25

Pièces de rechange				
PCFN R/L 12CA-12	114	124	-	-
PCFN R/L 16CA-12	112	122	A1	D1
PCFN R/L 20CA-16	B5	C5	Y2	D5
PCFN R/L 25CA-19	113	123	A2	131

Plaquettes	d	l	s	CNMA	CNMM	CNMG
CNM..1204..	12,7	12,9	4,76			
CNM..1606..	15,88	16,1	6,35			
CNM..1906..	19,05	19,3	6,35			

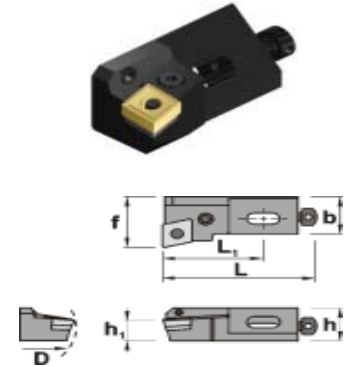

## PCGN 90°

Cartouches avec blocage par levier

	CODE ISO	D	h	h1	L	f	b
M	PCFN R/L 16CA-12	60	25	16	63	25	20
M	PCFN R/L 25CA-19	100	38	25	100	32	25

Pièces de rechange				
PCFN R/L 16CA-12	112	122	A1	D1
PCFN R/L 25CA-19	113	123	A2	131

Plaquettes	d	l	s	CNMA	CNMM	CNMG
CNM..1204..	12,7	12,9	4,76			
CNM..1906..	19,05	19,3	6,35			

## PCLN 95°

Cartouches avec blocage par levier

	CODE ISO	D	h	h1	L	L1	f	b
D	PCLN R/L 16CA-12	60	25	16	63	38	25	20
D	PCLN R/L 20CA-12	70	30	20	70	40	25	20
D	PCLN R/L 25CA-16	100	35	25	100	50	32	25

Pièces de rechange									
PCLN R/L 16CA-12	B12	VC48	3	A1	D1	CC06	G5	PO12	2,5
PCLN R/L 20CA-12	B1	C1	3	A1	D1	CC06	G6	PO12	3
PCLN R/L 25CA-16	B5	C5	3	Y2	D5	CC08	G8	PO15	4

Pièces de rechange			
PCLN R/L 16CA-12	JC08	AC08	5
PCLN R/L 20CA-12	JC08	AC08	5
PCLN R/L 25CA-16	JC10	AC10	6

Plaquettes	d	l	s	CNMG
CNM..1204..	12,7	12,9	4,76	
CNM..1606..	15,88	16,1	6,35	

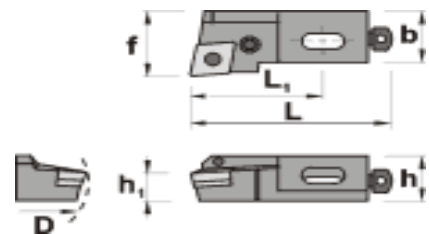

## SERMA OUTILLAGE

91 route de Bonsecours 59163 Condé sur l'Escaut FRANCE  
Tel: 03-27-30-12-31 Fax: 03-27-30-17-13



## PCLN 95°

Cartouches avec blocage par levier

	CODE ISO	D	h	h1	L	f	b
M	PCLN R/L 12CA-12	50	20	12	55	20	15
M	PCLN R/L 16CA-12	55	25	16	63	25	20
M	PCLN R/L 20CA-16	70	30	20	70	20	20
M	PCLN R/L 25CA-19	100	38	25	100	32	25

Pièces de rechange				
PCLN R/L 12CA-12	114	124	-	-
PCLN R/L 16CA-12	112	122	A1	D1
PCLN R/L 20CA-16	B5	C5	Y2	D5
PCLN R/L 25CA-19	113	123	A2	131

Plaquettes	d	l	s	CNMA	CNMM	CNMG
CNM...1204..	12,7	12,9	4,76			
CNM...1606..	15,88	16,1	6,35			
CNM...1906..	19,05	19,3	6,35			

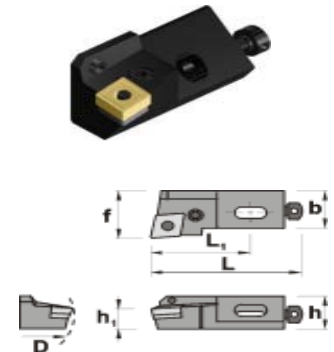

## PSKN 75°

Cartouches avec blocage par levier

	CODE ISO	D	h	h1	L	L1	f	b
D	PSKN R/L 12CA-12	50	20	12	55	35	20	16
D	PSKN R/L 16CA-12	60	25	16	63	38	25	20
D	PSKN R/L 20CA-12	70	30	20	70	40	25	20
D	PSKN R/L 25CA-15	100	35	25	100	50	32	25

Pièces de rechange										
PSKN R/L 12CA-12	BL12	VC26	2,5	-	-	CC05	G5	-	2,5	
PSKN R/L 16CA-12	B12	VC48	3	A1	D1	CC06	G5	PO12	2,5	
PSKN R/L 20CA-12	B1	C1	3	A1	D1	CC06	G6	PO12	3	
PSKN R/L 25CA-15	B5	C5	3	Y1	D5	CC08	G8	PO15	4	

Pièces de rechange			
PSKN R/L 12CA-12	JC06	AC06	4
PSKN R/L 16CA-12	JC08	AC08	5
PSKN R/L 20CA-12	JC08	AC08	5
PSKN R/L 25CA-15	JC10	AC10	6

Plaquettes	d	l	s	SNMA	SNMG
SNM...1204..	12,7	12,7	4,76		
SNM...1506..	15,88	15,88	6,35		

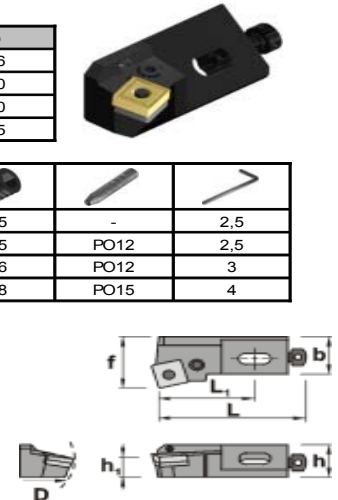

## PSKN 75°

Cartouches avec blocage par levier

	CODE ISO	D	h	h1	L	f	b
M	PSKN R/L 12CA-12	50	20	12	55	20	16
M	PSKN R/L 16CA-12	55	25	16	63	25	20
M	PSKN R/L 20CA-15	70	30	20	70	25	20
M	PSKN R/L 25CA-19	100	38	25	100	32	25

Pièces de rechange										
PSKN R/L 12CA-12	114	124	2,5	-	-	VA5	GRL12	2	VB12	4
PSKN R/L 16CA-12	112	122	3	A4	D1	VA6	GRL16	2,5	VB16	5
PSKN R/L 20CA-15	B5	C5c	3	Y1	D5	VA6	GRL20	2,5	VB20	5
PSKN R/L 25CA-19	113	123	4	A5	131	VA8	GRL25	3	VB25(n°2)	6

Plaquettes	d	l	s	SNMG	SNMA
SNM...1204..	12,7	12,7	4,76		
SNM...1506..	15,88	15,88	6,35		
SNM...1906..	19,05	19,05	6,35		

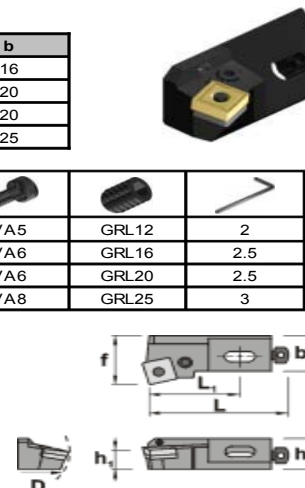



## PSRN 75°

Cartouches avec blocage par levier

	CODE ISO	D	h	h1	L	L1	f	b
D	PSRN R/L 16CA-12	60	25	16	63	38	25	20
D	PSRN R/L 20CA-12	70	30	20	70	40	25	20



Pièces de rechange									
PSRN R/L 16CA-12	B12	CV48	3	A4	D1	CC06	G5	PO12	2,5
PSRN R/L 20CA-12	B1	C1	3	A4	D1	CC06	G6	PO12	3

Pièces de rechange			
PSRN R/L 16CA-12	JC08	AC08	5
PSRN R/L 20CA-12	JC08	AC08	5

Plaquettes	d	l	s	SNMA	SNMG
SNM.. 1204..	12,7	12,7	4,76		

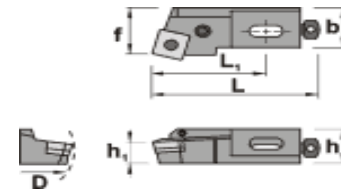

## PSRN 75°

Cartouches avec blocage par levier

	CODE ISO	D	h	h1	L	f	b
M	PSRN R/L 16CA-12	60	25	16	63	25	20
M	PSRN R/L 20CA-15	70	30	20	70	25	20



Pièces de rechange										
PSRN R/L 16CA-12	112	122	3	A4	D1	VA6	GRL16	2,5	VB16	5
PSRN R/L 20CA-15	B5	C5c	3	Y1	D5	VA6	GRL20	2,5	VB20	5

Plaquettes	d	l	s	SNMG	SNMA
SNMG 1204..	12,7	12,7	4,76		
SNMG 1506..	15,88	15,88	6,35		

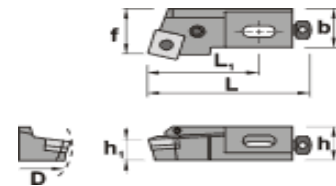

## PSSN 45°

Cartouches avec blocage par levier

	CODE ISO	D	h	h1	L	L1	f	b
D	PSSN R/L 12CA-12	50	20	12	47	27	20	16
D	PSSN R/L 16CA-12	60	25	16	53	28	25	20
D	PSSN R/L 20CA-12	70	30	20	60	30	25	20



Pièces de rechange									
PSSN R/L 12CA-12	BL12	VC26	2,5	-	-	CC05	G5	-	2,5
PSSN R/L 16CA-12	B12	VC48	3	A4	D1	CC06	G5	PO12	2,5
PSSN R/L 20CA-12	B1	C1	3	A4	D1	CC06	G6	PO12	3

Pièces de rechange			
PSSN R/L 12CA-12	JC06	AC06	4
PSSN R/L 16CA-12	JC08	AC08	5
PSSN R/L 20CA-12	JC08	AC08	5

Plaquettes	d	l	s	SNMA	SNMG
SNMG 1204..	12,7	12,7	4,76		

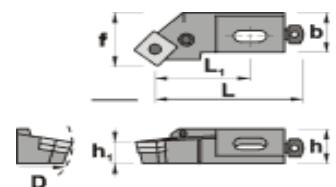

## SERMA OUTILLAGE

91 route de Bonsecours 59163 Condé sur l'Escaut FRANCE  
Tel: 03-27-30-12-31 Fax: 03-27-30-17-13



M	PSSN R/L 20CA-15	70	30	20	60	25	20
---	------------------	----	----	----	----	----	----

Pièces de rechange										
PSSN R/L 12CA-12	114	124	2,5	-	-	VA5	GRL12	2	VB12	4
PSSN R/L 16CA-12	112	122	3	A4	D1	VA6	GRL16	2,5	VB16	5
PSSN R/L 20CA-15	B5	C5c	3	Y1	D5	VA6	GRL20	2,5	VB20	5

Plaquettes	d	l	s	SNMG	SNMA
SNMG 1204..	12,7	12,7	4,76		

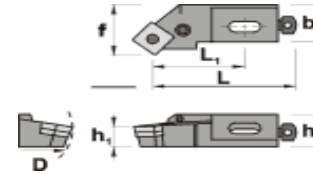

## PTFN 90°

Cartouches avec blocage par levier

	CODE ISO	D	h	h1	L	L1	f	b
D	PTFN R/L 12CA-16	50	20	12	55	35	20	16
D	PTFN R/L 16CA-16	60	25	16	63	38	25	20
D	PTFN R/L 20CA-22	70	30	20	70	40	25	20
D	PTFN R/L 25CA-22	100	35	25	100	50	32	25



Pièces de rechange										
PTFN R/L 12CA-16	BL16	VC05	2	-	-	CC05	G5	-	-	2,5
PTFN R/L 16CA-16	B4	C3	2,5	A6	DR09	CC06	G5	PO09	-	2,5
PTFN R/L 20CA-22	B1	C1	3	A7	D1	CC06	G6	PO12	-	3
PTFN R/L 25CA-22	B1	C1	3	A7	D1	CC08	G6	PO12	-	4

Pièces de rechange			
PTFN R/L 12CA-16	JC06	AC06	4
PTFN R/L 16CA-16	JC08	AC08	5
PTFN R/L 20CA-22	JC08	AC08	5
PTFN R/L 25CA-22	JC10	AC10	6

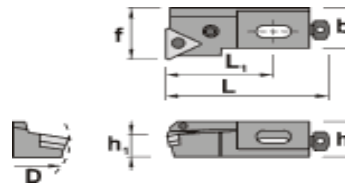

Plaquettes	d	l	s	TNMG
TNM 1604..	9,52	16,5	4,76	
TNM 2204..	12,7	22	4,76	

## PTFN 90°

Cartouches avec blocage par levier

	CODE ISO	D	h	h1	L	f	b
M	PTFN R/L 12CA-16	50	20	12	55	20	15
M	PTFN R/L 16CA-16	55	25	16	63	25	20
M	PTFN R/L 20CA-22	70	30	20	70	25	20
M	PTFN R/L 25CA-27	100	38	25	100	32	25



Pièces de rechange										
PTFN R/L 12CA-16	111	121	2	-	-	VA5	GRL12	2	VB12	4
PTFN R/L 16CA-16	B4	C3	2,5	A6	D3	VA6	GRL16	2,5	VB16	5
PTFN R/L 20CA-22	B1	C1	3	A7	D1	VA6	GRL20	2,5	VB20	5
PTFN R/L 25CA-27	H2	H5	3	H1	D5	VA8	GRL25	3	VB25(n°2)	6

Plaquettes	d	l	s	TNMM	TNMG	TNMA
TNM 1604..	9,52	16,5	4,76			
TNM 2204..	12,7	22	4,76			
TNM..27..	15,87	27,5	6,35			

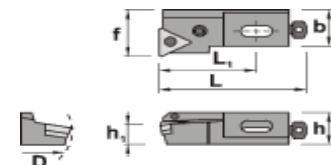



## PTGN 90°

Cartouches avec blocage par levier

	CODE ISO	D	h	h1	L	L1	f	b
D	PTGN R/L 12CA-16	50	20	12	55	35	20	16
D	PTGN R/L 16CA-16	60	25	16	63	38	25	20
D	PTGN R/L 20CA-22	70	30	20	70	40	25	20



Pièces de rechange									
PTGN R/L 12CA-16	BL16	VC05	2	-	-	CC05	G5	-	2,5
PTGN R/L 16CA-16	B4	C3	2,5	A6	DR09	CC06	G5	PO09	2,5
PTGN R/L 20CA-22	B1	C1	3	A7	D1	CC06	G6	PO12	3

Pièces de rechange			
PTGN R/L 12CA-16	JC06	AC06	4
PTGN R/L 16CA-16	JC08	AC08	5
PTGN R/L 20CA-22	JC08	AC08	5

Plaquettes	d	l	s	TNMG
TNM 1604..	9,52	16,5	4,76	
TNM 2204..	12,7	22	4,76	

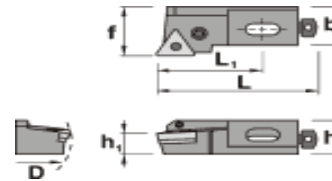

## PTGN 90°

Cartouches avec blocage par levier

	CODE ISO	D	h	h1	L	f	b
M	PTGN R/L 12CA-16	50	20	12	55	20	15
M	PTGN R/L 16CA-16	55	25	16	63	25	20
M	PTGN R/L 20CA-22	70	30	20	70	25	20



Pièces de rechange									
PTGN R/L 12CA-16	111	121	2	-	-	VA5	GRL12	2	VB12
PTGN R/L 16CA-16	B4	C3	2,5	A6	D3	VA6	GRL16	2,5	VB16
PTGN R/L 20CA-22	B1	C1	3	A7	D1	VA6	GRL20	2,5	VB20

Plaquettes	d	l	s	TNMM	TNMG	TNMA
TNM 1604..	9,52	16,5	4,76			
TNM 2204..	12,7	22	4,76			

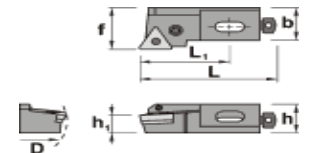

## PTSN 45°

Cartouches avec blocage par levier

	CODE ISO	D	h	h1	L	L1	f	b
D	PTSN R/L 12CA-16	50	20	12	47	27	20	16
D	PTSN R/L 16CA-16	60	25	16	53	28	25	20
D	PTSN R/L 20CA-22	70	30	20	60	30	25	20
D	PTSN R/L 25CA-22	100	35	25	67	37	32	25



Pièces de rechange									
PTSN R/L 12CA-16	BL16	VC05	2	-	-	CC05	G5	-	2,5
PTSN R/L 16CA-16	B4	C3	2,5	A6	DR09	CC06	G5	PO09	2,5
PTSN R/L 20CA-22	B1	C1	3	A7	D1	CC06	G6	PO12	3
PTSN R/L 25CA-22	B1	C1	3	A7	D1	CC08	G8	PO12	4

Pièces de rechange			
PTSN R/L 12CA-16	JC06	AC06	4
PTSN R/L 16CA-16	JC08	AC08	5
PTSN R/L 20CA-22	JC08	AC08	5
PTSN R/L 25CA-22	JC10	AC10	6

Plaquettes	d	l	s	TNMG
TNM 1604..	9,52	16,5	4,76	
TNM 2204..	12,7	22	4,76	

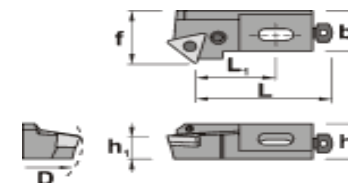

## SERMA OUTILLAGE

91 route de Bonsecours 59163 Condé sur l'Escaut FRANCE  
Tel: 03-27-30-12-31 Fax: 03-27-30-17-13





## PTSN 45°

Cartouches avec blocage par levier

	CODE ISO	D	h	h1	L	f	b
M	PTSN R/L 12CA-16	50	20	12	47	20	15
M	PTSN R/L 16CA-16	55	25	16	53	25	20
M	PTSN R/L 20CA-22	70	30	20	60	25	20



Pièces de rechange										
PTSN R/L 12CA-16	111	121	2	-	-	VA5	GRL12	2	VB12	4
PTSN R/L 16CA-16	B4	C3	2,5	A6	D3	VA6	GRL16	2,5	VB16	5
PTSN R/L 20CA-22	B1	C1	3	A7	D1	VA6	GRL20	2,5	VB20	5

Plaquettes	d	l	s	TNMM	TNMG	TNMA
TNM 1604..	9,52	16,5	4,76			
TNM 2204..	12,7	22	4,76			

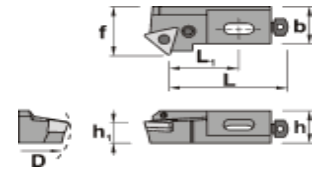

## PTTN 60°

Cartouches avec blocage par levier

	CODE ISO	D	h	h1	L	L1	f	b
D	PTTN R/L 12CA-16	50	20	12	55	35	13	16
D	PTTN R/L 16CA-16	60	25	16	63	38	15	20
D	PTTN R/L 20CA-22	70	30	20	60	40	15	20



Pièces de rechange										
PTTN R/L 12CA-16	BL16	VC05	2	-	-	CC05	G5	-	2,5	
PTTN R/L 16CA-16	B4	C3	2,5	A6	DR09	CC06	G5	PO09	2,5	
PTTN R/L 20CA-22	B1	C1	3	A7	D1	CC06	G6	PO12	3	

Pièces de rechange			
PTTN R/L 12CA-16	JC06	AC06	4
PTTN R/L 16CA-16	JC08	AC08	5
PTTN R/L 20CA-22	JC08	AC08	5

Plaquettes	d	l	s	TNMG
TNM 1604..	9,52	16,5	4,76	
TNM 2204..	12,7	22	4,76	

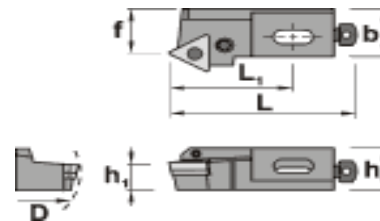

## PTTN 60°

Cartouches avec blocage par levier

	CODE ISO	D	h	h1	L	f	b
M	PTTN R/L 12CA-16	50	20	12	55	13	15
M	PTTN R/L 16CA-16	60	25	16	63	15	20
M	PTTN R/L 20CA-22	70	30	20	70	15	20



Pièces de rechange										
PTTN R/L 12CA-16	111	121	2	-	-	VA5	GRL12	2	VB12	4
PTTN R/L 16CA-16	B4	C3	2,5	A6	D3	VA6	GRL16	2,5	VB16	5
PTTN R/L 20CA-22	B1	C1	3	A7	D1	VA6	GRL20	2,5	VB20	5

Plaquettes	d	l	s	TNMM	TNMG	TNMA
TNM 1604..	9,52	16,5	4,76			
TNM 2204..	12,7	22	4,76			

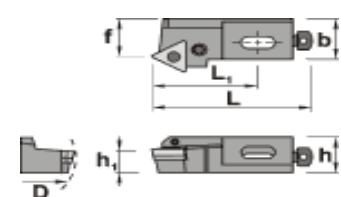

## SERMA OUTILLAGE

91 route de Bonsecours 59163 Condé sur l'Escaut FRANCE  
Tel: 03-27-30-12-31 Fax: 03-27-30-17-13





## PTWN 30°

Cartouches avec blocage par levier

	CODE ISO	D	h	h1	L	L1	f	b
D	PTWN R/L 12CA-16	50	20	12	47	27	20	16
D	PTWN R/L 16CA-16	60	25	16	53	28	25	20
D	PTWN R/L 20CA-22	70	30	20	60	30	25	20



Pièces de rechange									
PTWN R/L 12CA-16	BL16	VC05	2	-	-	CC05	G5	-	2,5
PTWN R/L 16CA-16	B4	C3	2,5	A6	DR09	CC06	G5	PO09	2,5
PTWN R/L 20CA-22	B1	C1	3	A7	D1	CC06	G6	PO12	3

Pièces de rechange			
PTWN R/L 12CA-16	JC06	AC06	4
PTWN R/L 16CA-16	JC08	AC08	5
PTWN R/L 20CA-22	JC08	AC08	5

Plaquettes	d	l	s	TNMG
TNM 1604..	9,52	16,5	4,76	
TNM 2204..	12,7	22	4,76	

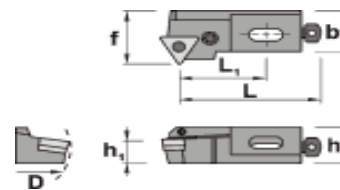

## PTWN 30°

Cartouches avec blocage par levier

	CODE ISO	D	h	h1	L	f	b
M	PTWN R/L 12CA-16	50	20	12	47	20	15
M	PTWN R/L 16CA-16	55	25	16	53	25	20
M	PTWN R/L 20CA-22	70	30	20	60	25	20



Pièces de rechange										
PTWN R/L 12CA-16	111	121	2	-	-	VA5	GRL12	2	VB12	4
PTWN R/L 16CA-16	B4	C3	2,5	A6	D3	VA6	GRL16	2,5	VB16	5
PTWN R/L 20CA-22	B1	C1	3	A7	D1	VA6	GRL20	2,5	VB20	5

Plaquettes	d	l	s	TNMM	TNMG	TNMA
TNM 1604..	9,52	16,5	4,76			
TNM 2204..	12,7	22	4,76			

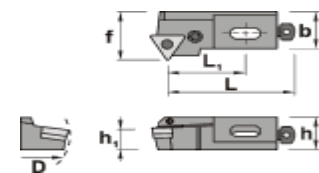

## SCFC 90°

Cartouches avec blocage par vis

	CODE ISO	D	h	h1	L	L1	f	b
D	SCFC R/L 06CA-06	20	6	6	25	15	10	6
D	SCFC R/L 08CA-06	25	8	8	27	16	12	7
D	SCFC R/L 10CA-09	30	14	10	42	24	14	10
D	SCFC R/L 12CA-12	40	16	12	47	35	20	14

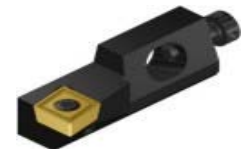

Pièces de rechange								
SCFC R/L 06CA-06	CC25	CTX7	CC03	G3	1,5	JC03	AC03	2
SCFC R/L 08CA-06	CC25	CTX7	CC03	G3	1,5	JC04	AC04	2,5
SCFC R/L 10CA-09	CC40	CTX15	CC05	G4	2	JC06	AC06	4
SCFC R/L 12CA-12	CC50	CTX20	CC05	G5	2,5	JC06	AC06	4

Plaquettes	d	l	s	CCGT	CCMT	CCMW
CC.. 0602..	6,35	6,45	2,38			
CC.. 09T3..	9,52	9,65	3,97			
CC.. 1204..	12,7	12,9	4,76			

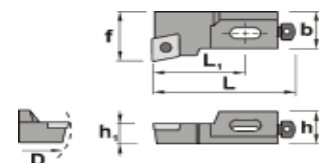

## SERMA OUTILLAGE

91 route de Bonsecours 59163 Condé sur l'Escaut FRANCE  
Tel: 03-27-30-12-31 Fax: 03-27-30-17-13



## SCFC 90°

Cartouches avec blocage par vis

	CODE ISO	D	h	h1	L	f	b
M	SCFC R/L 10CA-09	40	15	10	44	14	11

Pièces de rechange							
SCFC R/L 10CA-09	V4c	Tx15	VA5	GR10	2	VB10	4

Plaquettes	d	l	s	CCMM	CCMA
CCM.. 09T3..	9,52	9,65	3,97		

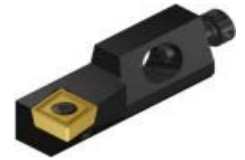
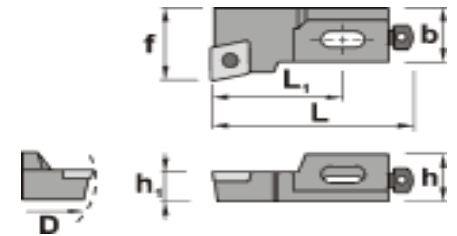

## SCLC 95°

Cartouches avec blocage par vis

	CODE ISO	D	h	h1	L	L1	f	b
D	SCLC R/L 06CA-06	20	6	6	25	15	10	6
D	SCLC R/L 08CA-06	25	8	8	27	16	12	7
D	SCLC R/L 10CA-09	30	14	10	42	24	14	10
D	SCLC R/L 12CA-12	40	16	12	47	35	20	14

Pièces de rechange								
SCLC R/L 06CA-06	CC25	CTX7	CC03	G3	1,5	JC03	AC03	2
SCLC R/L 08CA-06	CC25	CTX7	CC03	G3	1,5	JC04	AC04	2,5
SCLC R/L 10CA-09	CC40	CTX15	CC05	G4	2	JC06	AC06	4
SCLC R/L 12CA-12	CC50	CTX20	CC05	G5	2,5	JC06	AC06	4

Plaquettes	d	l	s	CCGT	CCMT	CCMW
CC.. 0602..	6,35	6,45	2,38			
CC.. 09T3..	9,52	9,65	3,97			
CC.. 1204..	12,7	12,9	4,76			

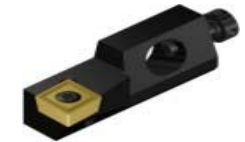
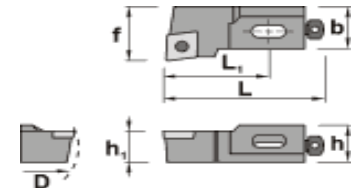

## SCLC 95°

Cartouches avec blocage par vis

	CODE ISO	D	h	h1	L	f	b
M	SCLC R/L 10CA-09	40	15	10	44	14	11

Pièces de rechange							
SCLC R/L 10CA-09	V4c	Tx15	VA5	GR10	2	VB10	4

Plaquettes	d	l	s	CCMM	CCMA
CCM.. 09T3..	9,52	9,65	3,97		

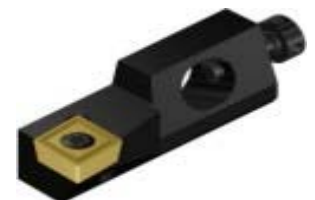
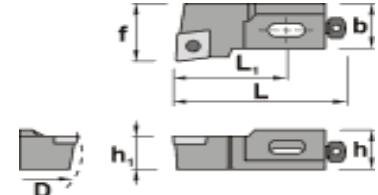

## SERMA OUTILLAGE

91 route de Bonsecours 59163 Condé sur l'Escaut FRANCE  
Tel: 03-27-30-12-31 Fax: 03-27-30-17-13



## SSKC 75°

Cartouches avec blocage par vis

	CODE ISO	D	h	h1	L	L1	f	b
D	SSKC R/L 10CA-09	30	14	10	50	30	14	10
D	SSKC R/L 12CA-12	40	16	12	55	35	20	14
D	SSKC R/L 16CA-12	50	20	16	63	38	25	17,5

Pièces de rechange								
SSKC R/L 10CA-09	V40C	CTX15	CC05	G4	2	JC06	AC16	4
SSKC R/L 12CA-12	CC50	CTX20	CC05	G5	2,5	JC06	AC06	4
SSKC R/L 16CA-12	CC50	CTX20	CC06	G5	2,5	JC08	AC08	5

Plaquettes	d	l	s	SCGT	SCMT	SCMW
SC.. 09T3..	9,52	9,52	3,97			
SC.. 1204..	12,7	12,7	4,76			

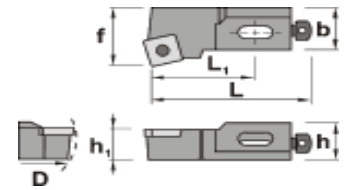

## SSKC 75°

Cartouches avec blocage par vis

	CODE ISO	D	h	h1	L	f	b
M	SSKC R/L 10CA-09	40	15	10	50	14	10
M	SSKC R/L 12CA-12	50	20	12	55	20	15

Pièces de rechange							
SSKC R/L 10CA-09	V4c	Tx15	VA5	GR10	2	VB10	4
SSKC R/L 12CA-12	V5	Tx20	VA5	GR12	2	VB12	4

Plaquettes	d	l	s	SCMM	SCMA
SC.. 09T3..	9,52	9,52	3,97		
SC.. 1204..	12,7	12,7	4,76		

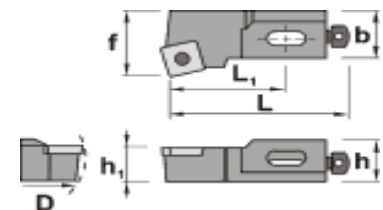

## SSSC 45°

Cartouches avec blocage par vis

	CODE ISO	D	h	h1	L	L1	f	b
D	SSSC R/L 10CA-09	30	14	10	44	24	14	10
D	SSSC R/L 12CA-12	40	16	12	47	27	20	14
D	SSSC R/L 16CA-12	50	20	16	53	28	25	17,5

Pièces de rechange								
SSSC R/L 10CA-09	V40C	CTX15	CC05	G4	2	JC06	AC16	4
SSSC R/L 12CA-12	CC50	CTX20	CC05	G5	2,5	JC06	AC06	4
SSSC R/L 16CA-12	CC50	CTX20	CC06	G5	2,5	JC08	AC08	5

Plaquettes	d	l	s	SCGT	SCMT	SCMW
SC.. 09T3..	9,52	9,52	3,97			
SC.. 1204..	12,7	12,7	4,76			

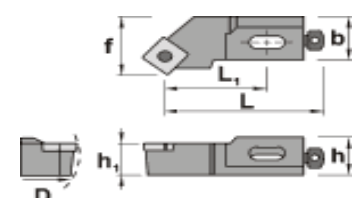

## SERMA OUTILLAGE

91 route de Bonsecours 59163 Condé sur l'Escaut FRANCE  
Tel: 03-27-30-12-31 Fax: 03-27-30-17-13



## SSSC 45°

Cartouches avec blocage par vis

	CODE ISO	D	h	h1	L	f	b
M	SSSC R/L 10CA-09	40	15	10	44	14	10
M	SSSC R/L 12CA-12	50	20	12	47	20	12



Pièces de rechange							
SSSC R/L 10CA-09	V4c	Tx15	VA5	GR10	2	VB10	4
SSSC R/L 12CA-12	V5	Tx20	VA5	GR12	2	VB12	4

Plaquettes	d	l	s	SCMM	SCMA
SC..09T3..	9,52	9,52	3,97		
SC.. 1204..	12,7	12,7	4,76		

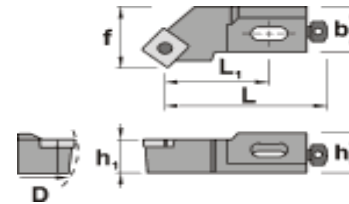

## STFC 90°

Cartouches avec blocage par vis

	CODE ISO	D	h	h1	L	L1	f	b
D	STFC R/L 08CA-09	25	8	8	36	15	10	7
D	STFC R/L 08CA-11	25	8	8	36	15	10	7
D	STFC R/L 10CA-11	30	14	10	50	30	14	10
D	STFC R/L 12CA-16	40	16	12	55	35	20	14
D	STFC R/L 16CA-16	50	20	16	63	38	25	17,5



Pièces de rechange								
STFC R/L 08CA-09	V22C	CTX6	CC03	G3	1,5	JC04	AC04	2,5
STFC R/L 08CA-11	V25C	CTX7	CC03	G3	1,5	JC04	AC04	2,5
STFC R/L 10CA-11	V25C	CTX7	CC05	G4	2	JC06	AC16	4
STFC R/L 12CA-16	V40C	CTX15	CC05	G5	2,5	JC06	AC06	4
STFC R/L 16CA-16	V40C	CTX15	CC06	G5	2,5	JC08	AC08	5

Plaquettes	d	l	s	TCGT	TCMT	TCMW
TC..0902..	5,55	9,62	2,38			
TC.. 1102..	6,35	11	2,38			
TC.. 16T3..	9,52	16,5	3,97			

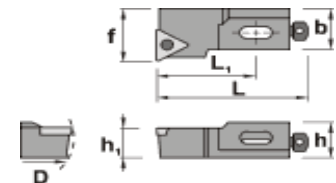

## STFC 90°

Cartouches avec blocage par vis

	CODE ISO	D	h	h1	L	f	b
M	STFC R/L 10CA-11	40	15	10	50	14	11
M	STFC R/L 12CA-16	50	20	12	55	20	15
M	STFC R/L 16CA-16	55	21	16	63	25	20



Pièces de rechange										
STFC R/L 10CA-11	V25	Tx7	-	-	-	VA5	GR10	2	VB10	4
STFC R/L 12CA-16	V4c	Tx15	-	-	-	VA5	GR12	2	VB12	4
STFC R/L 16CA-16	V35	Tx15	W3	X01	3,5	VA6	GR16	2	VB16	5

Plaquettes	d	l	s	TCMM	TCMA
TC.. 1102..	6,35	11	2,38		
TC.. 16T3..	9,52	16,5	3,97		

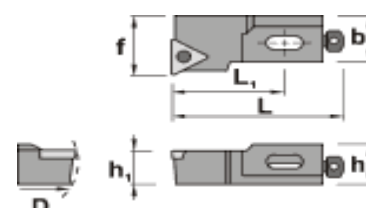

## SERMA OUTILLAGE

91 route de Bonsecours 59163 Condé sur l'Escaut FRANCE  
Tel: 03-27-30-12-31 Fax: 03-27-30-17-13



## STGC 90°

Cartouches avec blocage par vis

	CODE ISO	D	h	h1	L	L1	f	b
D	STGC R/L 10CA-11	30	14	10	50	30	14	10
D	STGC R/L 12CA-16	40	16	12	55	35	20	14
D	STGC R/L 16CA-16	50	20	16	63	38	25	17,5



Pièces de rechange								
STGC R/L 10CA-11	V25C	CTX7	CC05	G4	2	JC06	AC16	4
STGC R/L 12CA-16	V40C	CTX7	CC05	G5	2,5	JC06	AC06	4
STGC R/L 16CA-16	V40C	CTX15	CC06	G5	2,5	JC08	AC08	5

Plaquettes	d	l	s	TCGT	TCMT	TCMW
TC.. 1102..	6,35	11	2,38			
TC.. 16T3..	9,52	16,5	3,97			

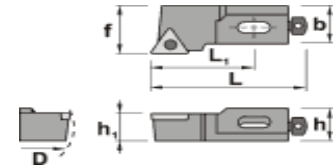

## STGC 90°

Cartouches avec blocage par vis

	CODE ISO	D	h	h1	L	f	b
M	STGC R/L 10CA-11	40	15	10	50	14	11
M	STGC R/L 12CA-16	50	20	12	55	20	15
M	STGC R/L 16CA-16	60	21	16	63	25	20



Pièces de rechange										
STGC R/L 10CA-11	V25	Tx7	-	-	-	VA5	GR10	2	VB10	4
STGC R/L 12CA-16	V4c	Tx15	-	-	-	VA5	GR12	2	VB12	4
STGC R/L 16CA-16	V35	Tx15	W3	X01	3,5	VA6	GR16	2	VB16	5

Plaquettes	d	l	s	TCMM	TCMA
TC.. 1102..	6,35	11	2,38		
TC.. 16T3..	9,52	16,5	3,97		

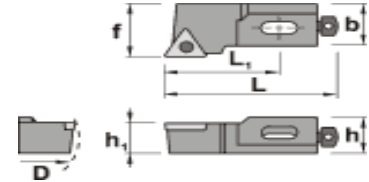

## STSC 45°

Cartouches avec blocage par vis

	CODE ISO	D	h	h1	L	L1	f	b
D	STSC R/L 08CA-09	25	8	8	27	16	10	7
D	STSC R/L 08CA-11	25	8	8	27	16	10	7
D	STSC R/L 10CA-11	30	14	10	44	24	14	10
D	STSC R/L 12CA-16	40	16	12	47	27	20	14
D	STSC R/L 16CA-16	50	20	16	53	28	25	17,5



Pièces de rechange								
STSC R/L 08CA-09	V22C	CTX6	CC03	G3	1,5	JC04	AC04	2,5
STSC R/L 08CA-11	V25C	CTX7	CC03	G3	1,5	JC04	AC04	2,5
STSC R/L 10CA-11	V25C	CTX7	CC05	G4	2	JC06	AC16	4
STSC R/L 12CA-16	V40C	CTX15	CC05	G5	2,5	JC06	AC06	4
STSC R/L 16CA-16	V40C	CTX15	CC06	G5	2,5	JC08	AC08	5

Plaquettes	d	l	s	TCGT	TCMT	TCMW
TC..0902..	5,55	9,62	2,38			
TC..1102..	6,35	11	2,38			
TC..16T3..	9,52	16,5	3,97			

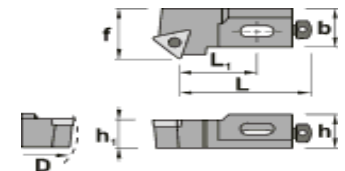

## SERMA OUTILLAGE

91 route de Bonsecours 59163 Condé sur l'Escaut FRANCE  
Tel: 03-27-30-12-31 Fax: 03-27-30-17-13





## STSC 45°

Cartouches avec blocage par vis

	CODE ISO	D	h	h1	L	f	b
M	STSC R/L 10CA-11	40	15	10	44	14	11
M	STSC R/L 12CA-16	50	20	12	47	20	15
M	STSC R/L 16CA-16	55	21	16	53	25	20



Pièces de rechange										
STSC R/L 10CA-11	V25	Tx7	-	-	-	VA5	GR10	2	VB10	4
STSC R/L 12CA-16	V4c	Tx15	-	-	-	VA5	GR12	2	VB12	4
STSC R/L 16CA-16	V35	Tx15	W3	X01	3,5	VA6	GR16	2	VB16	5

Plaquettes	d	l	s	TCMM	TCMA
TC.. 1102..	6,35	11	2,38		
TC.. 16T3..	9,52	16,5	3,97		



## STTC 60°

Cartouches avec blocage par vis

	CODE ISO	D	h	h1	L	L1	f	b
D	STTC R/L 08CA-09	25	8	8	27	15	6	7
D	STTC R/L 08CA-11	25	8	8	27	15	6	7
D	STTC R/L 10CA-11	30	14	10	50	30	9	10
D	STTC R/L 12CA-16	40	16	12	55	35	13	14
D	STTC R/L 16CA-16	50	20	16	63	38	15	17,5



Pièces de rechange								
STTC R/L 08CA-09	V22C	CTX6	CC03	G3	1,5	JC04	AC04	2,5
STTC R/L 08CA-11	V25C	CTX7	CC03	G3	1,5	JC04	AC04	2,5
STTC R/L 10CA-11	V25C	CTX7	CC05	G4	2	JC06	AC16	4
STTC R/L 12CA-16	V40C	CTX15	CC05	G5	2,5	JC06	AC06	4
STTC R/L 16CA-16	V40C	CTX15	CC06	G5	2,5	JC08	AC08	5

Plaquettes	d	l	s	TCGT	TCMT	TCMW
TC..0902..	5,55	9,62	2,38			
TC.. 1102..	6,35	11	2,38			
TC.. 16T3..	9,52	16,5	3,97			

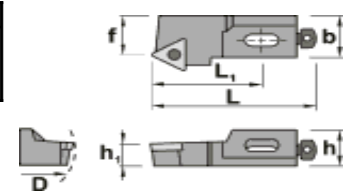

## STTC 60°

Cartouches avec blocage par vis

	CODE ISO	D	h	h1	L	f	b
M	STTC R/L 10CA-11	40	15	10	50	9	11
M	STTC R/L 12CA-16	50	20	12	55	13	15
M	STTC R/L 16CA-16	60	21	16	63	15	20



Pièces de rechange										
STTC R/L 10CA-11	V25	Tx7	-	-	-	VA5	GR10	2	VB10	4
STTC R/L 12CA-16	V4c	Tx15	-	-	-	VA5	GR12	2	VB12	4
STTC R/L 16CA-16	V35	Tx15	W3	X01	3,5	VA6	GR16	2	VB16	5

Plaquettes	d	l	s	TCMM	TCMA
TC.. 1102..	6,35	11	2,38		
TC.. 16T3..	9,52	16,5	3,97		

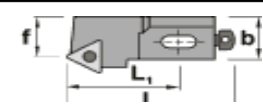





## STWC 60°

Cartouches avec blocage par vis

	CODE ISO	D	h	h1	L	L1	f	b
D	STWC R/L 08CA-11	25	8	8	27	16	10	7
D	STWC R/L 10CA-11	30	14	10	44	24	14	10
D	STWC R/L 12CA-16	40	16	12	47	27	20	14
D	STWC R/L 16CA-16	50	20	16	53	28	25	17,5



Pièces de rechange								
STWC R/L 08CA-11	V25C	CTX7	CC03	G3	1,5	JC04	AC04	2,5
STWC R/L 10CA-11	V25C	CTX7	CC05	G4	2	JC06	AC16	4
STWC R/L 12CA-16	V40C	CTX15	CC05	G5	2,5	JC06	AC06	4
STWC R/L 16CA-16	V40C	CTX15	CC06	G5	2,5	JC08	AC08	5

Plaquettes	d	l	s	TCGT	TCMT	TCMW
TC.. 1102..	6,35	11	2,38			
TC.. 16T3..	9,52	16,5	3,97			

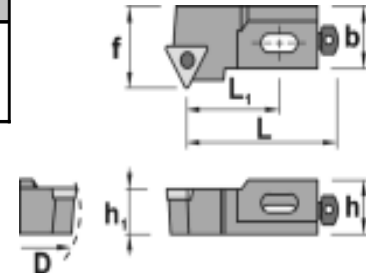

## STWC 60°

Cartouches avec blocage par vis

	CODE ISO	D	h	h1	L	f	b
M	STWC R/L 10CA-11	40	15	10	44	14	11
M	STWC R/L 12CA-16	50	20	12	47	20	15
M	STWC R/L 16CA-16	60	21	16	53	25	20



Pièces de rechange										
STWC R/L 10CA-11	V25	Tx7	-	-	-	VA5	GR10	2	VB10	4
STWC R/L 12CA-16	V4c	Tx15	-	-	-	VA5	GR12	2	VB12	4
STWC R/L 16CA-16	V35	Tx15	W3	X01	3,5	VA6	GR16	2	VB16	5

Plaquettes	d	l	s	TCMM	TCMA
TC.. 1102..	6,35	11	2,38		
TC.. 16T3..	9,52	16,5	3,97		

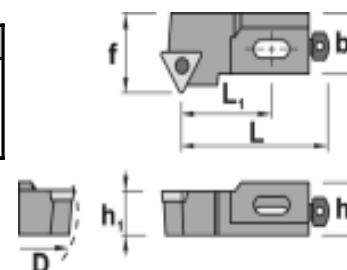

## SERMA OUTILLAGE

91 route de Bonsecours 59163 Condé sur l'Escaut FRANCE  
Tel: 03-27-30-12-31 Fax: 03-27-30-17-13